



CHENMKO ENTERPRISE CO.,LTD



BAW56DPT

SURFACE MOUNT

FAST SWITCHING DIODE ARRAY

VOLTAGE 75 Volts CURRENT 150 mAmpere

Lead free devices

APPLICATION

- * Ultra high speed switching
- * For general purpose switching application

FEATURE

- * Small surface mounting type. (SC-88/SOT-363)
- * High speed. (TRR=1.5nSec Typ.)
- * Suitable for high packing density.
- * Maximum total power dissipation is 200mW.
- * Peak forward current is 300mA.

CONSTRUCTION

- * Silicon epitaxial planar

MARKING

- * DC

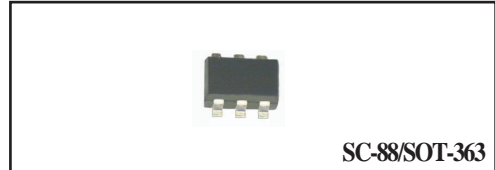

SC-88/SOT-363

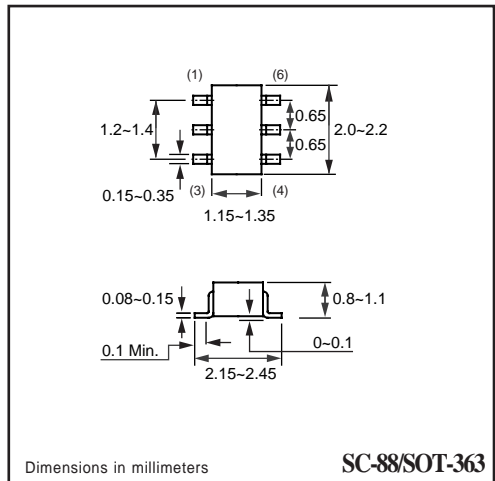

CIRCUIT

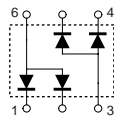

MAXIMUM RATINGS (At TA = 25°C unless otherwise noted)

RATINGS	SYMBOL	BAW56DPT	UNITS
Maximum Non-Repetitive Peak Reverse Voltage	V _{RM}	100	Volts
Maximum RMS Voltage	V _{RMS}	53	Volts
Maximum Repetitive Peak Reverse and DC Blocking Voltage	V _{RRM, VDC}	75	Volts
Maximum Average Forward Rectified Current	I _O	150	mAmps
Non-Repetitive Peak Forward Surge Current	@t=1.0uSec	2.0	Amps
	@t=1.0Sec	1.0	
Typical Junction Capacitance between Terminal (Note 1)	C _J	2.0	pF
Maximum Reverse Recovery Time (Note 2)	T _{RR}	4.0	nSec
Thermal Resistance Junction to Ambient (Note 3)	R _{θJA}	625	°C/W
Maximum Operating and Storage Temperature Range	T _{J, TSTG}	-65 to +150	°C

ELECTRICAL CHARACTERISTICS (At TA = 25°C unless otherwise noted)

CHARACTERISTICS	SYMBOL	BAW56DPT	UNITS
Maximum Instantaneous Forward Voltage	V _F	@I _F =1.0mA	0.715
		@I _F =10mA	0.855
		@I _F =50mA	1.00
		@I _F =150mA	1.25
Maximum Average Reverse Current	I _R	@V _R =20V	25
		@V _R =75V	2.5
		@V _R =25V, T _J =150°C	30
		@V _R =75V, T _J =150°C	50

- NOTES :
1. Measured at 1.0 MHz and applied reverse voltage of 0 volts.
 2. Measured at applied forward current of 10mA and reverse current of 10mA.
 3. Device mounted on FR-4 by 1 inch X 0.85 inch X 0.062 inch
 4. ESD sensitive product handling required.

RATING CHARACTERISTIC CURVES (BAW56DPT)

FIG. 1 - TYPICAL FORWARD CURRENT DERATING CURVE

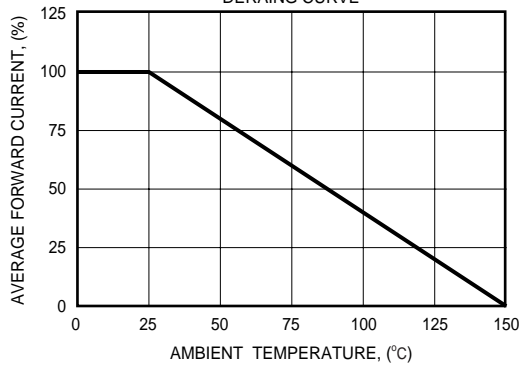

FIG. 2 - FORWARD CHARACTERISTICS

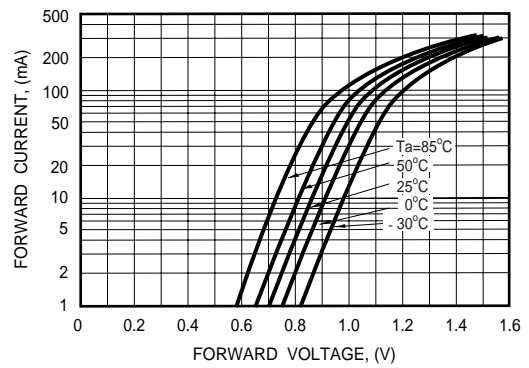

FIG. 3 - TYPICAL JUNCTION CAPACITANCE

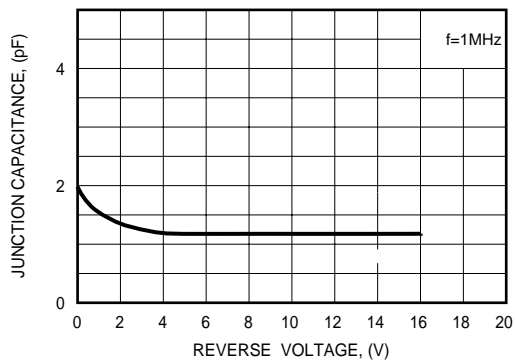

FIG. 4 - REVERSE CHARACTERISTICS

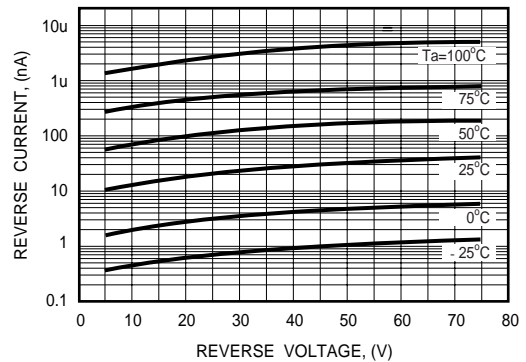

FIG. 5 - REVERSE RECOVERY TIME

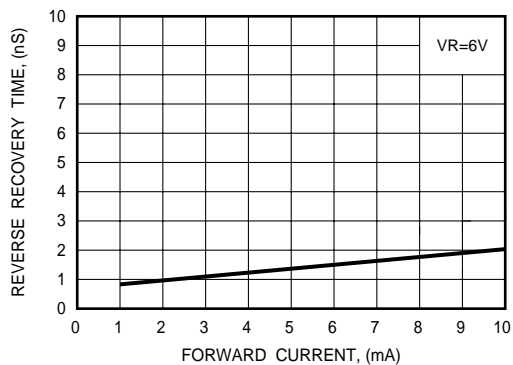

FIG. 6 - REVERSE RECOVERY TIME MEASUREMENT CIRCUIT

